

HO 54 W/830

LUMILUX T5 HO | Tubular fluorescent lamps 16 mm, high output



- Industry
- Public buildings
- Offices
- Tunnels, underpasses
- Car parks

Product benefits

- Excellent luminous flux
- Up to 20 % more economical than LUMILUX T8
- Up to 50 % smaller volume than comparable T8 lamps
- Natural colors

Product features

- Very good lumen maintenance: >90 % throughout the life of the lamp
- Long average life time: up to 24,000 h (with QUICKTRONIC ECG)
- Good color rendering group: 1B (R_a : 80...89)
- Dimmable



Technical data

Electrical data

Nominal voltage	230 V
Nominal wattage	54 W
Rated lamp efficacy (HF data)	Under clarification by authority and standardization body
Rated lamp efficacy (standard condition)	82 lm/W
Rated wattage	54.1 W

Light technical data

Color rendering index Ra	>=80
Rated luminous flux	4450 lm
Luminous flux at 25 °C	4450 lm
Luminous flux at 35 °C	5000 lm
Light color	830
Color temperature	3000 K
Nominal luminous flux	4450 lm
Light color as per EN 12464-1	LUMILUX Warm White
Rated LLMF at 2,000 h	0.95
Rated LLMF at 4,000 h	0.92
Rated LLMF at 6,000 h	0.91
Rated LLMF at 8,000 h	0.90
Rated LLMF at 12,000 h	0.90
Rated LLMF at 16,000 h	0.89
Rated LLMF at 20,000 h	0.89

Dimensions & weight

Tube diameter	16 mm
Length	1149.0 mm
Length with base excl. base pins/connection	1149.00 mm

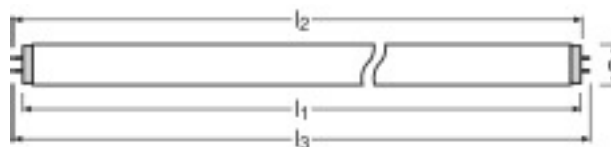

Product line drawing with letters

Product line drawing - technical

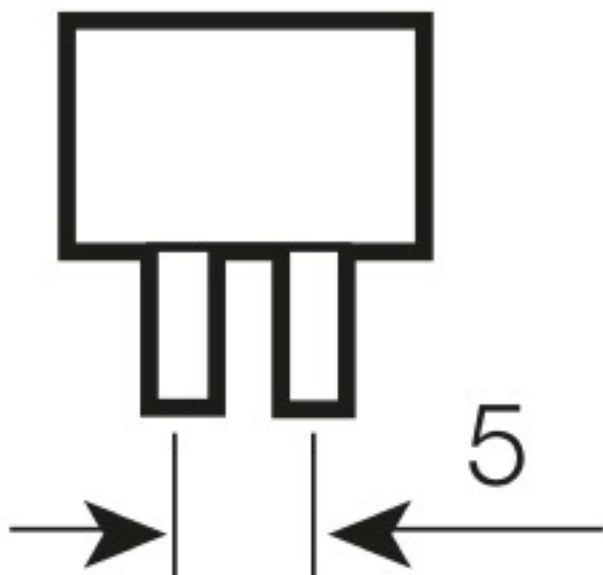

Base

Colors & materials

Lamp mercury content	1.4 mg
----------------------	--------

Temperatures

Rated ambient temp.w.max.luminous flux	35.0 °C
--	---------

Lifespan

Service life	19000 h ¹⁾
Lifespan	24000 h ¹⁾
Rated lamp survival factor at 2,000 h	0.99
Rated lamp survival factor at 4,000 h	0.99
Rated lamp survival factor at 6,000 h	0.99
Rated lamp survival factor at 8,000 h	0.99
Rated lamp survival factor at 12,000 h	0.99
Rated lamp survival factor at 16,000 h	0.95
Rated lamp survival factor at 20,000 h	0.81
Operation mode LLMF/LSF	HF

¹⁾ With preheat ECG

Additional product data

Base (standard designation)	G5
Appropriate disposal acc. to WEEE	Yes
Footnote used only for product	Suitable for ECG operation only/Lamp designed for internal luminaire temperatures of 30...40 °C; optimum luminous flux achieved at 35 °C

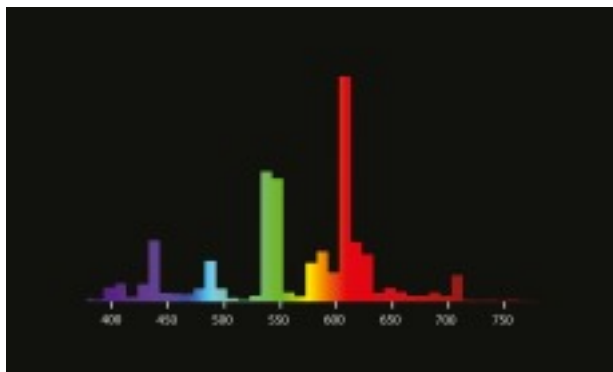

Spectral power distribution

Capabilities

Suitable for indoor	Yes
---------------------	-----

Certificates & standards

EEI – Energy Label	A
--------------------	---

System guarantee

OSRAM System+ Guarantee in combination with OSRAM ECGs

Safety advice

In case of lamp breakage: www.osram.com/brokenlamp

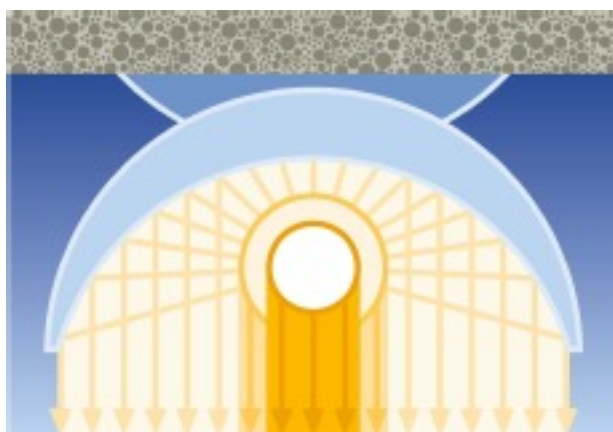

Others graphics

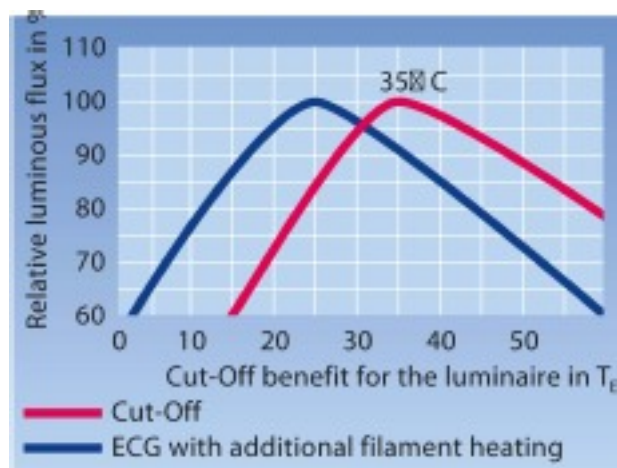

Others graphics

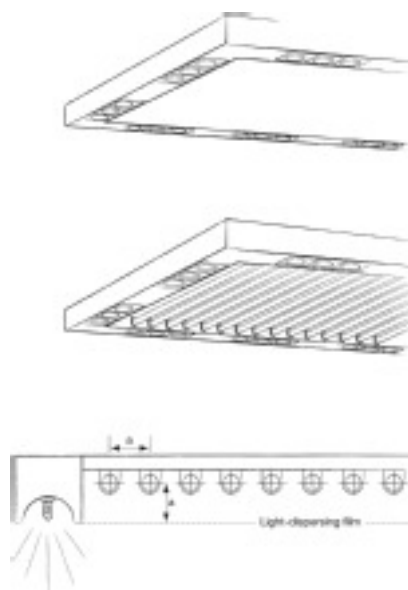

Others graphics

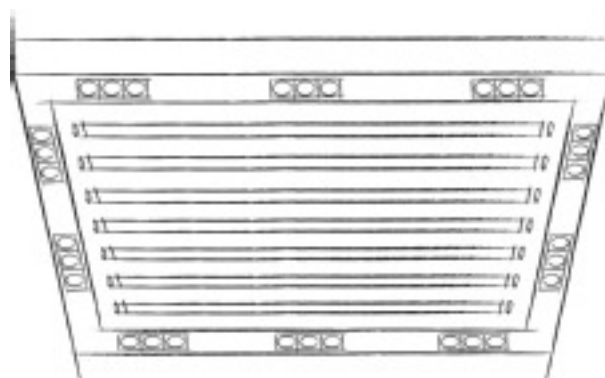

Others graphics

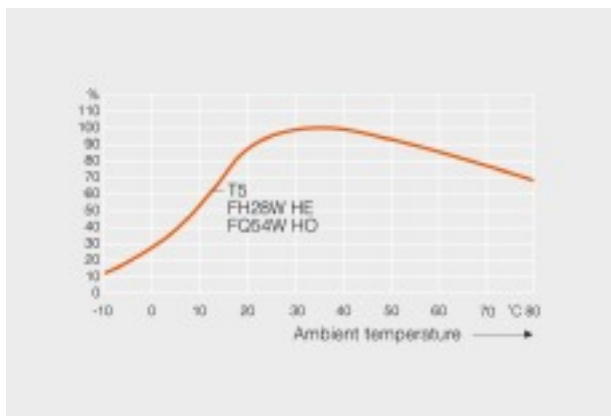

Others graphics

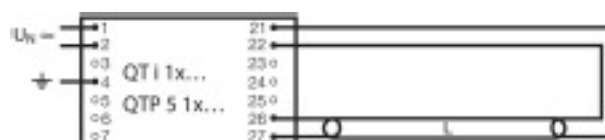

Circuit diagram



Circuit diagram

References / Links

For more information on QUICKTRONIC electronic control gear go to

▶ www.osram.com/QUICKTRONIC

Disclaimer

Subject to change without notice. Errors and omission excepted. Always make sure to use the most recent release.